



MIKE

Pendant control station



Pendant station for auxiliary control with modern ergonomic shape, easy to handle, user friendly and sturdy.

Mike is the result of careful analysis of ergonomic aspects and it is rich in high-performing features to meet the most demanding requirements.

FEATURES

- Reduced installation and wiring time and costs: the cable inlet and the switches fitted in the base of the control station are separated from the actuators, mounted on the cover.
- Innovative suspension system with concealed cables to enable rapid, correct, ergonomic installation.
- Rubber pushbuttons with symbol disks to ensure protection against dust and prevent jamming when the control station is used in harsh environments.
- The emergency stop mushroom pushbutton complies with standard ISO 13850.
- Positive opening NC contacts for safety functions.
- Mechanical life of pushbuttons and switches: 10 million operations.
- IP protection degree: Mike is classified IP 65, IP 66, IP 67 and IP 69K.
- IK protection degree: Mike is classified IK 08.
- NEMA protection degree: Mike is classified Type 1, 4 and 4X.
- Extreme temperature resistance: -40°C to +80°C.
- All materials and components used are wear resistant and guarantee protection of the unit against water and dust.

OPTIONS

- Available in configurations with 4 to 15 actuators.
- Available with specific protection for actuators mounted on

the bottom of the control station.

- 1NO or 1NC switches, LEDs voltage 24/48 Vac/dc or 110/230 Vac and 110 Vdc, and potentiometers.
- Mechanical interlock to prevent simultaneous operation of opposite functions.
- Wide range of actuators in different colours: one or two speed pushbuttons, selector switches and key-selector switches in various operation configurations, pilot lights, impulse or latched mushroom pushbuttons with rotation or key-operated release.
- One speed pushbuttons and selector switches available in illuminated version in a range of colours.
- Latched on-off maintained pushbutton to give an effective visual perception of the activated function.
- Available with labels (symbols and lettering) to be applied next to the actuators or with pushbuttons with two-colour moulded permanent symbols.

CERTIFICATIONS

- CE marking and cULus* marking.
- Mike is available, upon request, with the SIL1 certification (Safety Integrity Level 1), according to Standard IEC 61508.
- Complying with accident prevention regulation BGV C 1 (only for Germany).

Use the online configurator (<https://configuratore.terworld.com>) or fill in the "request form" for accurate product configuration.

* Not available on all versions.



CERTIFICATIONS

Conformity to Community Directives	2014/35/UE Low Voltage Directive
	2006/42/CE Machinery Directive
Conformity to CE Standards	EN 60204-1 Safety of machinery - Electrical equipment of machines
	EN 60947-1 Low-voltage switchgear and controlgear
	EN 60947-5-1 Low-voltage switchgear and controlgear - Control circuit devices and switching elements - Electromechanical control circuit devices
	EN 60947-5-5 Low-voltage switchgear and controlgear - Control circuit devices and switching elements - Electrical emergency stop device with mechanical latching function
	EN 60529 Degrees of protection provided by enclosures
Conformity to cULus Standards	ISO 13850 Safety of machinery - Emergency stop - Principles for design
	CSA-C22.2 No 14-13 Industrial Control Equipment
SIL1	UL 508 Industrial Control Equipment
	IEC 61508:2010 Part 2-4-6-7 Functional safety of electrical / electronic / programmable electronic safety-related systems
BGV C 1	Regulations for the prevention of accidents BGV C 1 (only for Germany)
Markings and homologations	CE eULus*

GENERAL TECHNICAL SPECIFICATIONS

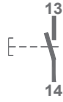

Ambient temperature	Storage -40°C/+80°C
	Operational -40°C/+80°C
IP protection degree	IP 65 / IP 66 / IP 67 / IP 69K
IK protection degree	IK 08
NEMA protection degree	Type 1, 4 and 4X
Insulation category	Class II
Cable entry	Rubber cable sleeve (Ø 8÷26 mm)
	Cable gland M20
Operating positions	Any position
Mechanical life	1 speed pushbutton: 10x10 ⁶ operations
	2 speed pushbutton: 10x10 ⁶ operations
	Illuminated pushbutton: 10x10 ⁶ operations

TECHNICAL SPECIFICATIONS OF THE SWITCHES

Code	PRSL1800PI	PRSL1801PI
Utilisation category	AC 15	
Rated operational current	3 A	
Rated operational voltage	250 Vac	
Rated thermal current	10 A	
Rated insulation voltage	300 Vac	
Electrical reliability EN 60947-5-4	$\lambda < 2.5 \times 10^{-8}$ at 24 V, 5 mA, 5x10 ⁶ cycles	-
Mechanical life	10x10 ⁶ operations	
Connections	Screw-type terminals	
Wires	2x0.5mm ² - 2x1.5 mm ² - 1x2.5 mm ² (UL (c)UL: use 60°C or 75°C copper (CU) conductors and stiff or flexible wire 14-22 AWG)	
Tightening torque	0.5 Nm	
Switch type	Double break, slow action	
Contacts	1NO	1NC (All NC contacts are of the positive opening operation type )
Scheme		
Markings and homologations	CE eULus	

* Not available on all versions.

TECHNICAL SPECIFICATIONS OF THE LEDS

Code	PRSL1820PI	PRSL1821PI
Rated operational voltage	24-48 Vac/dc	110-240 Vac and 110 Vdc
Rated current consumption	1.30-2.70 mA	1.15-2.50 mA
Scheme		
Markings and homologations	 	

TECHNICAL SPECIFICATIONS OF THE POTENTIOMETERS

Code of potentiometer with support	SL000157	SL000095	PRSL1897PI
Ohmic value	1 kΩ	5 kΩ	10 kΩ
IP protection degree	IP 65 / IP 67		
Power rating	Max 3 W		
Life time	25x10 ³ movements (minimum)		
Operational ambient temperature	-25°C/+70°C		
Mechanical angle	300° ±5%		
Actual electrical angle	270°		
Ohmic value tolerance	±10%		
Markings and homologations			

Code of potentiometer with support	PRSL1893PI	PRSL1891PI	PRSL1892PI
Ohmic value	1 kΩ	4.7 kΩ	10 kΩ
IP protection degree	IP 65		
Power rating	Max 0.4 W		
Life time	15x10 ³ movements (minimum)		
Operational ambient temperature	-25°C/+70°C		
Mechanical angle	300°		
Actual electrical angle	267°		
Ohmic value tolerance	±20%		
Markings and homologations			

OVERALL DIMENSIONS (mm)

Standard

With small lower protection

With large lower protection

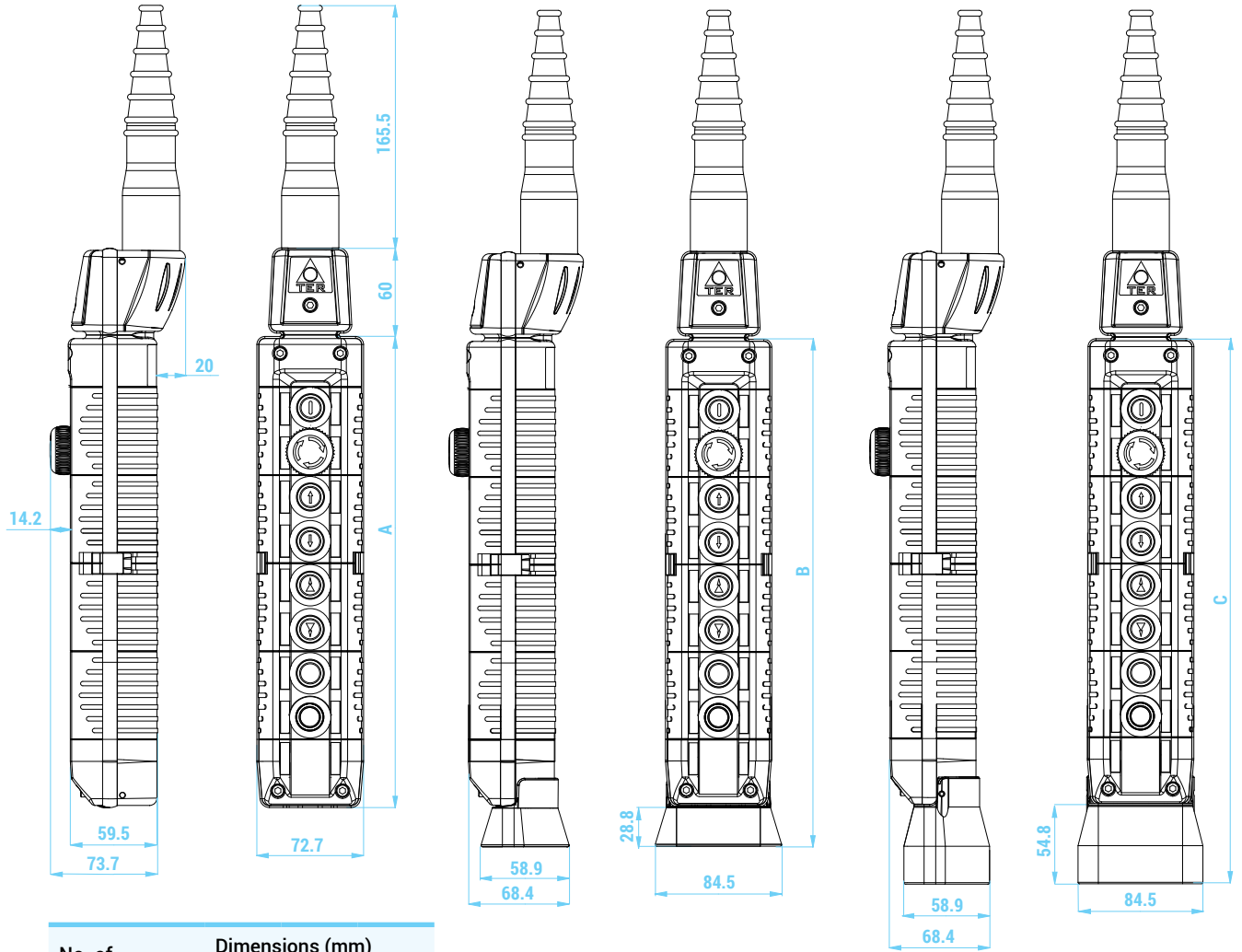

No. of actuators	Dimensions (mm)		
	A	B	C
4	201	229.8	255.8
5	201	229.8	255.8
6	261	289.8	315.8
7	261	289.8	315.8
8	321	349.8	375.8
9	321	349.8	375.8
12	441	469.8	495.8
13	441	469.8	495.8
14	501	529.8	555.8
15	501	529.8	555.8

Actuators

Key selector switch

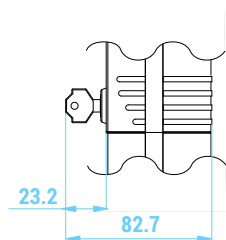

Selector switch

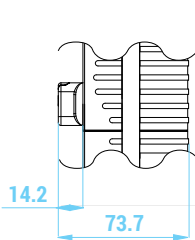

Key mushroom pushbutton

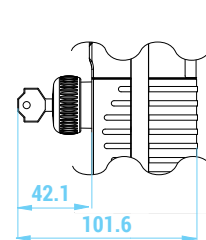

Mushroom pushbutton Ø 40 mm

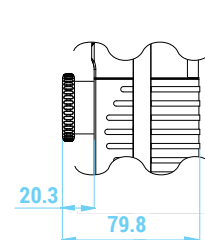

Potentiometer

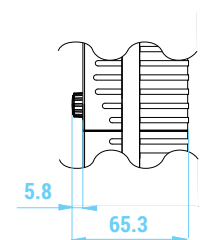



Dimensions of all mushroom pushbuttons refer to the released position.

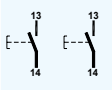

STANDARD CONTROL STATIONS

Standard control stations are not cULus certified.

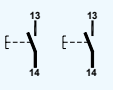

4 actuators

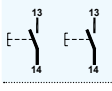
	Reset-Alarm button	Latched mushroom pushbutton	Black buttons mechanically interlocked between pairs		Cover colour	Code
	No.2 PRSL1800PI 1NO+1NO	No.1 PRSL1801PI 1NC	No.1 PRSL1800PI 1NO	No.2 PRSL1800PI 1NO+1NO		
						
	1	1	2		Yellow	F70AY12020000001
	1	1	2		Black	F70AB12020000001
	1	1		2	Yellow	F70AY12000200001
	1	1		2	Black	F70AB12000200001

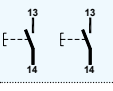

6 actuators

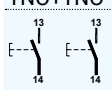
	Reset-Alarm button	Latched mushroom pushbutton	Black buttons mechanically interlocked between pairs		Cover colour	Code
	No.2 PRSL1800PI 1NO+1NO	No.1 PRSL1801PI 1NC	No.1 PRSL1800PI 1NO	No.2 PRSL1800PI 1NO+1NO		
						
	1	1	4		Yellow	F70EY12040000002
	1	1	4		Black	F70EB12040000001
	1	1		4	Yellow	F70EY12000400002
	1	1		4	Black	F70EB12000400001

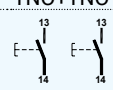

8 actuators

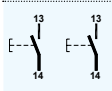
	Reset-Alarm button	Latched mushroom pushbutton	Black buttons mechanically interlocked between pairs		Cover colour	Code
	No.2 PRSL1800PI 1NO+1NO	No.1 PRSL1801PI 1NC	No.1 PRSL1800PI 1NO	No.2 PRSL1800PI 1NO+1NO		
						
	1	1	6		Yellow	F70BY12060000001
	1	1	6		Black	F70BB12060000001
	1	1		6	Yellow	F70BY12000600001
	1	1		6	Black	F70BB12000600001

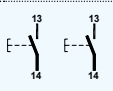
12 actuators

	Reset-Alarm button	Latched mushroom pushbutton	Black buttons mechanically interlocked between pairs		Cover colour	Code
	No.2 PRSL1800PI 1NO+1NO	No.1 PRSL1801PI 1NC	No.1 PRSL1800PI 1NO	No.2 PRSL1800PI 1NO+1NO		
						
	1	1	10		Yellow	F70CY12100000001
	1	1	10		Black	F70CB12100000001
	1	1		10	Yellow	F70CY12001000001
	1	1		10	Black	F70CB12001000001

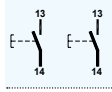
14 actuators

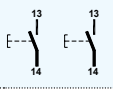
	Reset-Alarm button	Latched mushroom pushbutton	Black buttons mechanically interlocked between pairs		Cover colour	Code
	No.2 PRSL1800PI 1NO+1NO	No.1 PRSL1801PI 1NC	No.1 PRSL1800PI 1NO	No.2 PRSL1800PI 1NO+1NO		
						
	1	1	12		Yellow	F70DY12120000001
	1	1	12		Black	F70DB12120000001
	1	1		12	Yellow	F70DY12001200001
	1	1		12	Black	F70DB12001200001



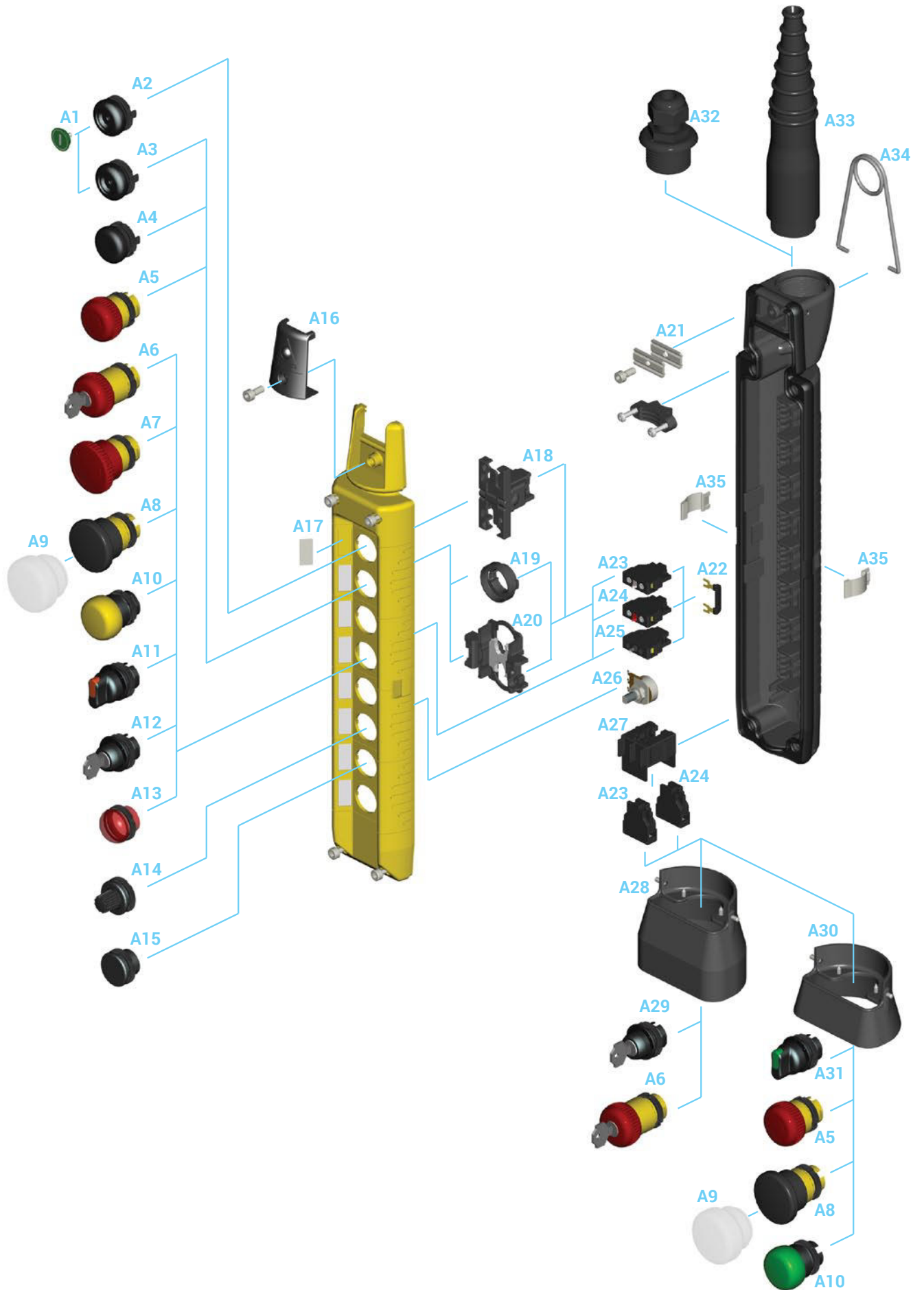



ASSEMBLY DRAWING



Refer to the following tables for descriptions of components: "Switches", "Potentiometers", "Actuators", "Pilot lights", "Mushroom pushbuttons", "Key selector switches", "Selector switches" and Accessories".

COMPONENTS







Switches

Ref.	Drawing	Description	Scheme	Code
A23		1NO switch		PRSL1800PI
A24		1NC switch		PRSL1801PI
A25		LED 24/48 Vac/dc		PRSL1820PI
		LED 110/230 Vac and 110 Vdc		PRSL1821PI

Potentiometers

Ref.	Drawing	Description	Code
A14 + A26		Potentiometer 1 kΩ - IP 65 / IP 67	SL000157
		Potentiometer 5 kΩ - IP 65 / IP 67	SL000095
		Potentiometer 10 kΩ - IP 65 / IP 67	PRSL1897PI
		Potentiometer 1 kΩ - IP 65	PRSL1893PI
		Potentiometer 4,7 kΩ - IP 65	PRSL1891PI
		Potentiometer 10 kΩ - IP 65	PRSL1892PI





Actuators

Ref.	Drawing	Description	Code
A1		Disk for pushbutton	PRTA_ _ _ _ _ See disk tables
A2		Pushbutton for latched ON-OFF maintained actuator	PRSL1803PI
A3		2 speed pushbutton	PRSL1810PI
		1 speed pushbutton	PRSL1811PI
		1 speed illuminated pushbutton	PRSL1815PI
A4		1 speed black pushbutton	PRSL1806PI
		1 speed grey pushbutton	PRSL1807PI
		2 speed black pushbutton	PRSL1808PI
A5		2 speed grey pushbutton	PRSL1809PI
		Blanking plug	PRSL1845PI
A18		Latched ON-OFF maintained actuator	PRSL1804PI



Pilot lights

Ref.	Drawing	Description	Code
A13		White	PRSL1844PI
		Green	PRSL1841PI
		Blue	PRSL1846PI
		Red	PRSL1840PI
		Yellow	PRSL1842PI
		Orange	PRSL1843PI



Mushroom pushbuttons

Ref.	Drawing	Description	Head colour	Code
A5		Latched mushroom pushbutton for emergency stop	Red	PRSL1880PI
A6		Key mushroom pushbutton	Red	PRSL1890PI
A7		Latched mushroom pushbutton for emergency stop Ø 40 mm	Red	PRSL1881PI
A8		Impulse mushroom pushbutton Ø 40 mm with yellow base	Black	PRSL1883PI
A10			Red	PRSL1885ROC
			Blue	PRSL1885BLC
			Yellow	PRSL1885GIC
			Green	PRSL1885VEC
			Orange	PRSL1885ARC
			Black	PRSL1885NEC

Key selector switches

Ref.	Drawing	Positions	Spring return	Maintained positions	Pull-out position	Code
A12 A29		0/1	X		0	PRSL1867PI
				X	0	PRSL1868PI
A12		1/0/2	X		0	PRSL1869PI
				X	0	PRSL1870PI
		0/1/1+2	X		0	PRSL1871PI
				X	0	PRSL1872PI
		1/2 change-over	X		1	PRSL1873PI
				X	1	PRSL1874PI
1/1+2/2	X		1+2	PRSL1875PI		
		X	1+2	PRSL1876PI		

Selector switches

Ref.	Drawing	Positions	Colour		Code
			Trasparent	Full	
A11 A31		0/1 Spring return	White		PRSL1855BI
			Green		PRSL1855VE
			Blue		PRSL1855BL
			Red		PRSL1855RO
			Yellow		PRSL1855GI
			Orange		PRSL1855AR
		0/1 Maintained	White		PRSL1856BI
			Green		PRSL1856VE
			Blue		PRSL1856BL
			Red		PRSL1856RO
			Yellow		PRSL1856GI
			Orange		PRSL1856AR
		0/1 Spring return		White	PRSL1855BIC
				Green	PRSL1855VEC
				Blue	PRSL1855BLC
				Red	PRSL1855ROC
				Yellow	PRSL1855GIC
				Orange	PRSL1855ARC
		0/1 Maintained		White	PRSL1856BIC
				Green	PRSL1856VEC
	Blue		PRSL1856BLC		
	Red		PRSL1856ROC		
	Yellow		PRSL1856GIC		
	Orange		PRSL1856ARC		
A11		1/0/2 Spring return	White		PRSL1857BI
			Green		PRSL1857VE
			Blue		PRSL1857BL
			Red		PRSL1857RO
			Yellow		PRSL1857GI
			Orange		PRSL1857AR
		1/0/2 Maintained	White		PRSL1858BI
			Green		PRSL1858VE
			Blue		PRSL1858BL
			Red		PRSL1858RO
			Yellow		PRSL1858GI
			Orange		PRSL1858AR
		1/0/2 Spring return		White	PRSL1857BIC
				Green	PRSL1857VEC
				Blue	PRSL1857BLC
				Red	PRSL1857ROC
				Yellow	PRSL1857GIC
				Orange	PRSL1857ARC
		1/0/2 Maintained		White	PRSL1858BIC
				Green	PRSL1858VEC
	Blue		PRSL1858BLC		
	Red		PRSL1858ROC		
	Yellow		PRSL1858GIC		
	Orange		PRSL1858ARC		







Selector switches

Ref.	Drawing	Positions	Colour		Code
			Trasparent	Full	
A11		1/1+2/2 Spring return	White		PRSL1863BI
			Green		PRSL1863VE
			Blue		PRSL1863BL
			Red		PRSL1863RO
			Yellow		PRSL1863GI
			Orange		PRSL1863AR
		1/1+2/2 Maintained	White		PRSL1864BI
			Green		PRSL1864VE
			Blue		PRSL1864BL
			Red		PRSL1864RO
			Yellow		PRSL1864GI
			Orange		PRSL1864AR
		1/1+2/2 Spring return		White	PRSL1863BIC
				Green	PRSL1863VEC
				Blue	PRSL1863BLC
				Red	PRSL1863ROC
				Yellow	PRSL1863GIC
				Orange	PRSL1863ARC
		1/1+2/2 Maintained		White	PRSL1864BIC
				Green	PRSL1864VEC
	Blue		PRSL1864BLC		
	Red		PRSL1864ROC		
	Yellow		PRSL1864GIC		
	Orange		PRSL1864ARC		
0/1/1+2 Spring return	White		PRSL1859BI		
	Green		PRSL1859VE		
	Blue		PRSL1859BL		
	Red		PRSL1859RO		
	Yellow		PRSL1859GI		
	Orange		PRSL1859AR		
0/1/1+2 Maintained	White		PRSL1860BI		
	Green		PRSL1860VE		
	Blue		PRSL1860BL		
	Red		PRSL1860RO		
	Yellow		PRSL1860GI		
	Orange		PRSL1860AR		
0/1/1+2 Spring return		White	PRSL1859BIC		
		Green	PRSL1859VEC		
		Blue	PRSL1859BLC		
		Red	PRSL1859ROC		
		Yellow	PRSL1859GIC		
		Orange	PRSL1859ARC		
0/1/1+2 Maintained		White	PRSL1860BIC		
		Green	PRSL1860VEC		
		Blue	PRSL1860BLC		
		Red	PRSL1860ROC		
		Yellow	PRSL1860GIC		
		Orange	PRSL1860ARC		



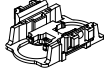

Selector switches

Ref.	Drawing	Positions	Colour		Code
			Trasparent	Full	
A11		1/2. Spring return	White		PRSL1861BI
			Green		PRSL1861VE
			Blue		PRSL1861BL
			Red		PRSL1861RO
			Yellow		PRSL1861GI
			Orange		PRSL1861AR
		1/2. Maintained	White		PRSL1862BI
			Green		PRSL1862VE
			Blue		PRSL1862BL
			Red		PRSL1862RO
			Yellow		PRSL1862GI
		1/2. Spring return		White	PRSL1861BIC
				Green	PRSL1861VEC
				Blue	PRSL1861BLC
				Red	PRSL1861ROC
				Yellow	PRSL1861GIC
				Orange	PRSL1861ARC
		1/2. Maintained		White	PRSL1862BIC
				Green	PRSL1862VEC
				Blue	PRSL1862BLC
	Red		PRSL1862ROC		
	Yellow		PRSL1862GIC		
		Orange	PRSL1862ARC		

Accessories

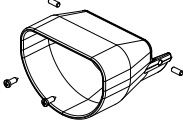
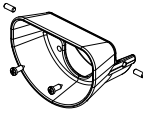
Ref.	Drawing	Description	Code
A9		Transparent protective cap for impulse mushroom pushbutton Ø 40 mm	PRGU6100PE
A16		Cable cover with TER logo	PRSL1832PI
		Blank cable cover	PRSL1836PI
A17		Label sheet - Symbols	PRET0215PE
		Label sheet - German	PRET0220DE
		Label sheet - English	PRET0220EN
		Label sheet - Spanish	PRET0220ES
		Label sheet - French	PRET0220FR
		Label sheet - Italian	PRET0220IT
A19		Button-switch spacer	PRSL8512PI
A20		Mechanical interlock	PRSL1850PI
A21		Complete wire clamp	PRSL1896PI
A22		Insulated connecting bridge - positions 3-4 (bag with 5 pieces)	PRSL1911PI
		Insulated connecting bridge - positions 2-4 (bag with 5 pieces)	PRSL1912PI
		Insulated connecting bridge - positions 1-4 (bag with 5 pieces)	PRSL1913PI
		Insulated connecting bridge - positions 1-3 (bag with 5 pieces)	PRSL1914PI
		Insulated connecting bridge - positions 1-2 (bag with 5 pieces)	PRSL1915PI
		Insulated connecting bridge - positions 1-2-3 (bag with 5 pieces)	PRSL1916PI

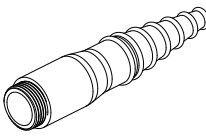
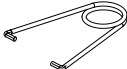
Accessories

Ref.	Drawing	Description	Code
A27		1-2-3 switch holder	PRSL8750PI
A28		Large protection	PRSL1831PI
A30		Small protection	PRSL1830PI
A32		Cable gland M20 with reduction	PRSL1910PI
A33		Cable sleeve	PRSL0145PE
A34		Hook	PRGA0012PE
A35		Closing clip	PRTR1035PE

Full colour disks



Transparent disks

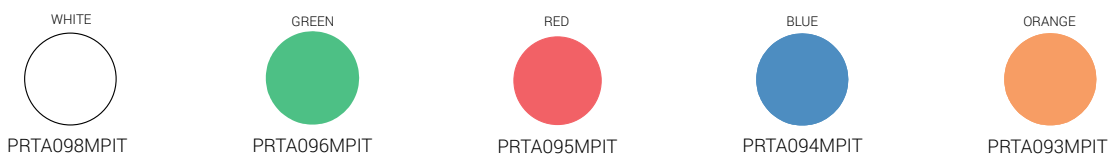

Label sheet - Symbols

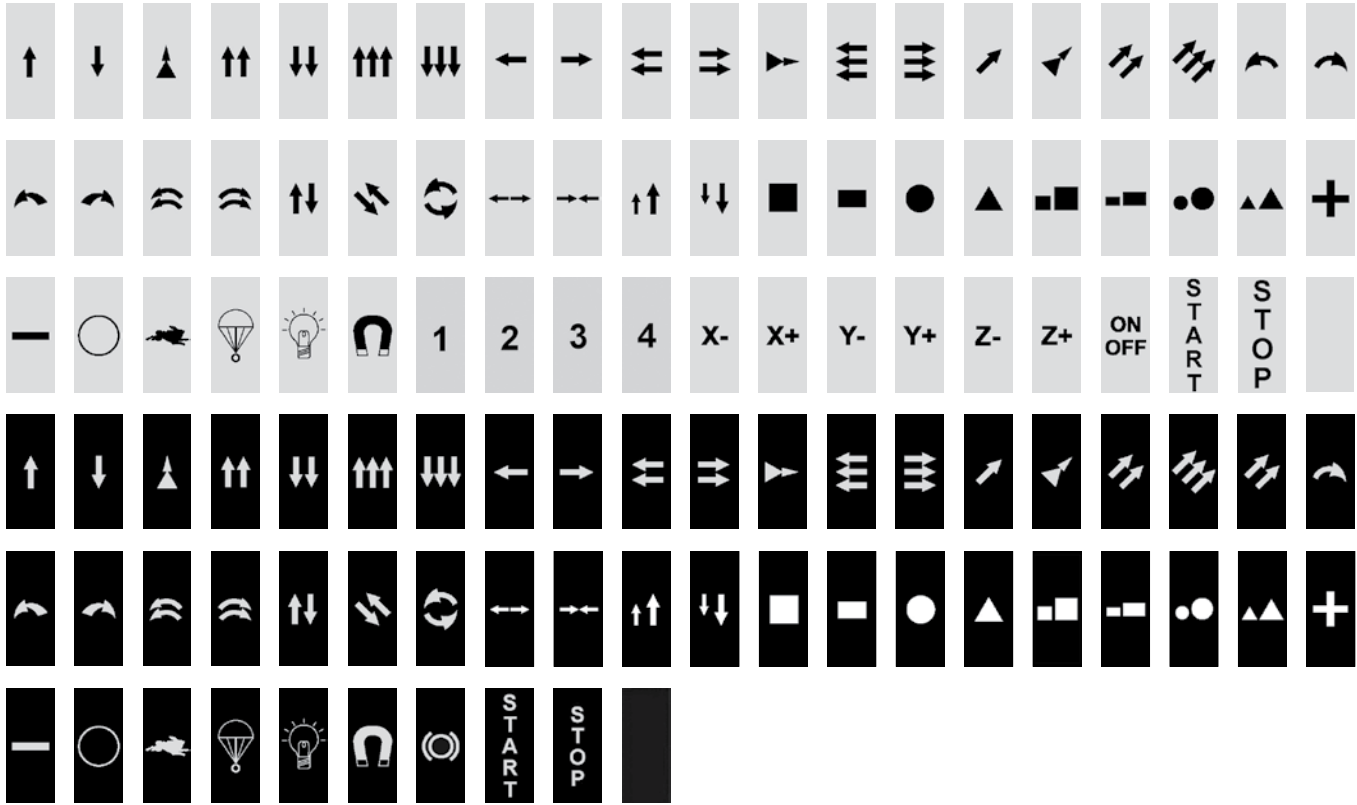

Label sheet - English

START	ALARM	RESET ALARM	RESET	STOP	LIGHT	RESET LINE	STOP LINE	START BUCKET	STOP BUCKET
BRAKE	BACK	UP	DOWN	UP LIFTING	DOWN LIFTING	UP LIFTING 1-2 SPEED	DOWN LIFTING 1-2 SPEED	UP LIFTING 3RD SPEED	DOWN LIFTING 3RD SPEED
UP LIFTING FAST	DOWN LIFTING FAST	LIFTING 2ND SPEED	LIFTING 3RDSPEED	UP AUXIL. LIFTING	DOWN AUXIL LIFTING	UP MAIN LIFTING	DOWN MAIN LIFTING	UP FAST MAIN LIFTING	DOWN FAST MAIN LIFTING
UP AUXIL. LIFTING 1-2 S.	DOWN AUXIL. LIFTING 1-2 S.	UP MAIN LIFTING 1-2 S.	DOWN MAIN LIFTING 1-2 S.	UP WINCH	DOWN WINCH	UP WINCH 1-2 SPEED	DOWN WINCH 1-2 SPEED	UP FAST WINCH	DOWN FAST WINCH
UP SLOW RIGHT WINCH	DOWN SLOW RIGHT WINCH	UP FAST RIGHT WINCH	DOWN FAST RIGHT WINCH	UP SLOW LEFT WINCH	UP FAST LEFT WINCH	DOWN FAST LEFT WINCH	UP HOIST	DOWN HOIST	UP HOIST 1-2 SPEED
DOWN HOIST 1-2 SPEED	UP FAST HOIST	DOWN FAST HOIST	FORWARD	BACKWARD	FORWARD TROLLEY	BACKWARD TROLLEY	FORWARD FAST TROLLEY	BACKWARD FAST TROLLEY	FORWARD TROLLEY 1-2 S.
BACKWARD TROLLEY 1-2 S.	FORWARD BRIDGE	BACKWARD BRIDGE	FORWARD FAST BRIDGE	BACKWARD FAST BRIDGE	FORWARD BRIDGE 1-2 S.	BACKWARD BRIDGE 1-2 S.	FORWARD TRANSLATION	BACKWARD TRANSLATION	LEFT
RIGHT	LEFT TROLLEY	RIGHT TROLLEY	LEFT FAST TROLLEY	RIGHT FAST TROLLEY	LEFT TROLLEY 1-2 S.	RIGHT TROLLEY 1-2 S.	LEFT BRIDGE	RIGHT BRIDGE	LEFT FAST BRIDGE
DOWN SLOW LEFT WINCH	RIGHT FAST BRIDGE	LEFT BRIDGE 1-2 S.	RIGHT BRIDGE 1-2 S.	CCW ROTATION	CW ROTATION	CCW FAST ROTATION	CW FAST ROTATION	CCW ROTATION 1-2 S.	CW ROTATION 1-2 S.
CCW ROTATION 3RD SPEED	CW ROTATION 3RD SPEED	LEFT CTRL STATION	RIGHT CTRL STATION	TROLLEY LEFT	TROLLEY RIGHT	SLOW	FAST	FAST TROLLEY	FAST BRIDGE
FAST LIFTING	FAST ROTATION	WINCH MATCHING	OPEN	CLOSE	OPEN GRAPPLE	CLOSE GRAPPLE	OPEN BUCKET	CLOSE BUCKET	OPEN DOOR
CLOSE DOOR	SPEED UP	SPEED DOWN	RAISE	LOWER	LOAD	DOWNLOAD	ENERGIZE	DE-ENERGIZE	ENERGIZE MAGNET
DE-ENERGIZE MAGNET	APPROACH	CONSENT	AUTOMATIC	MANUAL	MAN-0-AUTO	OFF-MAN-AUTO	ON	OFF	ON-OFF
IN	OUT	NORTH	SOUTH	EAST	WEST	OVERLOAD	TARE	1-1+2-2	1-2-1+2
1+2	ON-OFF	A-A+B-B							

Label sheet - Italian

MARCIA	ALLARME	MARCIA ALLARME	ARRESTO	STOP	LUCE	MARCIA LINEA	ARRESTO LINEA	MARCIA BENNA	ARRESTO BENNA
FRENO	RITORNO	SALITA	DISCESA	SALITA SOLLEV.	DISCESA SOLLEV.	SALITA SOLL. 1-2 VEL.	DISCESA SOLL. 1-2 VEL.	SALITA SOLL. 3a VEL.	DISCESA SOLL. 3a VEL.
SALITA SOLL. VEL.	DISCESA SOLL. VEL.	2a VELOCITÀ SOLLEV.	3a VELOCITÀ SOLLEV.	SALITA SOLL. AUSILIARIO	DISCESA SOLL. AUSILIARIO	SALITA SOLL. PRINCIPALE	DISCESA SOLL. PRINCIPALE	SALITA SOLL. PRINCIP. VEL.	DISCESA SOLL. PRINCIP. VEL.
SALITA AUSIL. 1-2 V.	DISCESA AUSIL. 1-2 V.	SALITA PRINCIP. 1-2 V.	DISCESA PRINCIP. 1-2 V.	SALITA ARGANO	DISCESA ARGANO	SALITA ARGANO 1-2 V.	DISCESA ARGANO 1-2 V.	SALITA ARGANO VEL.	DISCESA ARGANO VEL.
ARGANO DX SALITA LENTA	ARGANO DX DISC. LENTA	ARGANO DX SALITA VEL.	ARGANO DX DISCESA VEL.	ARGANO SIN SALITA LENTA	ARGANO SIN SALITA VEL.	ARGANO SIN DISCESA VEL.	SALITA PARANCO	DISCESA PARANCO	SALITA PAR. 1-2 V.
DISCESA PAR. 1-2 V.	SALITA PAR. VEL.	DISCESA PAR. VEL.	AVANTI	INDIETRO	AVANTI CARRELLO	INDIETRO CARRELLO	AVANTI CARR. VEL.	INDIETRO CARR. VEL.	AVANTI CARR. 1-2 V.
INDIETRO CARR. 1-2 V.	AVANTI PONTE	INDIETRO PONTE	AVANTI PONTE VEL.	INDIETRO PONTE VEL.	AVANTI PONTE 1-2 V.	INDIETRO PONTE 1-2 V.	AVANTI TRASLAZIONE	INDIETRO TRASLAZIONE	SINISTRA
DESTRA	SINISTRA CARRELLO	DESTRA CARRELLO	SINISTRA CARR. VEL.	DESTRA CARR. VEL.	SINISTRA CARR. 1-2 V.	DESTRA CARR. 1-2 V.	SINISTRA PONTE	DESTRA PONTE	SINISTRA PONTE VEL.
ARGANO SIN DISC. LENTA	DESTRA PONTE VEL.	SINISTRA PONTE 1-2 V.	DESTRA PONTE 1-2 V.	SINISTRA ROTAZIONE	DESTRA ROTAZIONE	SINISTRA ROTAZ. VEL.	DESTRA ROTAZ. VEL.	SINISTRA ROTAZ. 1-2 V.	DESTRA ROTAZ. 1-2 V.
SINISTRA ROTAZ. 3a V.	DESTRA ROTAZ. 3a V.	SINISTRA PULSANTIERA	DESTRA PULSANTIERA	CARRELLO SINISTRO	CARRELLO DESTRO	LENTO	VELOCE	VELOCE CARRELLO	VELOCE PONTE
VELOCE SOLLEV.	VELOCE ROTAZIONE	ACCOPPIAMENTO ARGANO	APRE	CHIUDE	APRE PINZA	CHIUDE PINZA	APRE BENNA	CHIUDE BENNA	APERTURA PORTELLO
CHIUSURA PORTELLO	ACCELERA	DECELERA	ALZA	ABBASSA	CARICO	SCARICO	ECCITA	DISECCITA	ECCITA MAGNETE
DISECCITA MAGNETE	ACCOSTA	CONSENSO	AUTOMATICO	MANUALE	MAN-0-AUTO	OFF-MAN-AUTO	ON	OFF	ON-OFF
IN	OUT	NORD	SUD	EST	OVEST	SOVRACCARICO	TARA	1-1+2-2	1-2-1+2
1+2	ON-OFF	A-A+B-B							

Label sheet - French

MARCHE	ALARME	MARCHE ALARME	RESET	ARRET	LUMIERE	MARCHE LIGNE	ARRET LIGNE	MARCHE BENNE	ARRET BENNE
FREIN	RETOUR	MONTEE	DESCENTE	MONTEE LEVAGE	DESCENTE LEVAGE	MONTEE LEV. 1-2 VIT.	DESCENTE LEV. 1-2 VIT.	MONTEE LEV. 3EME VIT.	DESCENTE LEV. 3EME VIT.
MONTEE LEV. VITE	DESCENTE LEV. VITE	MONTEE LEV. 2EME VIT.	DESCENTE LEV. 3EME VIT.	MONTEE LEV. AUXILIAIRE	DESCENTE LEV. AUXILIAIRE	MONTEE LEV. PRINCIPAL	DESCENTE LEV. PRINCIPAL	MONTEE LEV. PRINC. VITE	DESCENTE LEV. PRINC. VITE
MONTEE LEV. AUX. 1-2 VIT.	DESCENTE LEV. AUX. 1-2 VIT.	MONTEE LEV. PRINC. 1-2 VIT.	DESCENTE LEV. PRINC. 1-2 VIT.	MONTEE TREUIL	DESCENTE TREUIL	MONTEE TREUIL 1-2 VIT.	DESCENTE TREUIL 1-2 VIT.	MONTEE TREUIL VITE	DESCENTE TREUIL VITE
TREUIL DROITE MONTEE LENTE	TREUIL DROITE DESC. LENTE	TREUIL DROITE MONTEE VITE	TREUIL DROITE DESCENTE VITE	TREUIL AUICHE MONTEE LENTE	TREUIL AUICHE MONTEE VITE	TREUIL AUICHE DESCENTE VITE	MONTEE PALAN	DESCENTE PALAN	MONTEE PALAN 1-2 VIT.
DESC. PALAN 1-2 VIT.	MONTEE PALAN VITE	DESCENTE PALAN VITE	AVANT	ARRIERE	AVANT CHARIOT	ARRIERE CHARIOT	AVANT CHARIOT VITE	ARRIERE CHARIOT VITE	AVANT CHARIOT 1-2 VIT.
ARR. CHARIOT 1-2 VIT.	AVANT PONT	ARRIERE PONT	AVANT PONT VITE	ARRIERE PONT VITE	AVANT PONT 1-2 VIT.	ARRIERE PONT 1-2 VIT.	AVANT TRANSLATION	ARRIERE TRANSLATION	GAUCHE
DROITE	GAUCHE CHARIOT	DROITE CHARIOT	GAUCHE CHARIOT VITE	DROITE CHARIOT VITE	GAUCHE CHARIOT 1-2 VIT.	DROITE CHARIOT 1-2 VIT.	GAUCHE PONT	DROITE PONT	GAUCHE PONT VITE
TREUIL GAUCHE DESC. LENTE	DROITE PONT VITE	GAUCHE PONT 1-2 VIT.	DROITE PONT 1-2 VIT.	GAUCHE ROTATION	DROITE ROTATION	GAUCHE ROTATION VITE	DROITE ROTATION VITE	GAUCHE ROT. 1-2 VIT.	DROITE ROT. 1-2 VIT.
GAUCHE ROT. 3EME VIT.	DROITE ROT. 3EME VIT.	GAUCHE BOITE A BOUTONS	DROITE BOITE A BOUTONS	CHARIOT GAUCHE	CHARIOT DROITE	LENT	VITE	VITE CHARIOT	VITE PONT
VITE LEVAGE	VITE ROTATION	ACCOPPLEMNT. TREUIL	OUVRE	FERME	OUVRE PINCE	FERME PINCE	OUVRE BENNE	FERME BENNE	OUVRE PORTAIL
FERME PORTAIL	ACCELERATION	DECELERATION	HISSER	ABAISSE	CHARGE	DECHARGE	EXCITER	DESEXCITER	MAGNETISE
DEMAGNETISE	APPROCHE	CONSEMENT	AUTOMATIQUE	MANUEL	MAN-0-AUTO	OFF-MAN-AUTO	ON	OFF	ON-OFF
IN	OUT	NORD	SUD	EST	OUEST	SURCHARGE	TARE	1-1+2-2	1-2-1+2
1+2	ON-OFF	A-A+B-B							

Label sheet - German

BETRIEB	ALARM	FAHRT ALARM	SPERRE	STOP	LICHT	STROM AN	STROM AUS	GREIFER BETRIEB	GREIFER STOP
BREMSE	ZURUCK	RAUF	RUNTER	HUB RAUF	HUB RUNTER	HUB RAUF 1.-2. GANG	HUB RUNTER 1.-2. GANG	HUB RAUF 3. GANG	HUB RUNTER 3. GANG
HUB SCHNELL RAUF	HUB RUNTER SCHNELL	2. GANG HEBEN	3. GANG HEBEN	HILFSHUB RAUF	HILFSHUB RUNTER	HAUPTHUB RAUF	HAUPTHUB RUNTER	HAUPTHUB RAUF SCH.	HAUPTHUB RUNTER SCH.
HILFSHUB RAUF 1.-2. GANG	HILFSHUB RUNTER 1.-2. GANG	HAUPTHUB 1.-2. GANG	HAUPTHUB RUNTER 1.-2. GANG	WINDE RAUF	WINDE RUNTER	WINDE RAUF 1.-2. GANG	WINDE RUNTER 1.-2. GANG	WINDE RAUF SCHNELL	WINDE RUNTER SCHNELL
WINDE RECHTS LANGS. HOCH	WINDE RECHTS LANGS. RUNTER	WINDE RECHTS SCHNELL RAUF	WINDE RECHTS SCHNELL RUNTER	WINDE LINKS LANGSAM RAUF	WINDE LINKS SCHNELL RAUF	WINDE LINKS SCHNELL RUNTER	FLASCHENZUG HOCH	FLASCHENZUG RUNTER	FLASCHENZUG HOCH 1.-2. GANG
FLASCHENZUG RUNTER 1.-2. GANG	FLASCHENZUG HOCH SCHNELL	FLASCHENZUG RUNTER SCHNELL	VORWÄRTS	RÜCKWÄRTS	LAUFKATZE VORWÄRTS	LAUFKATZE RÜCKWÄRTS	LAUFKATZ VORWÄRTS SCHNELL	LAUFKATZE RÜCKWÄRTS SCHNELL	LAUFKATZE VORW. 1.-2. GANG
LAUFKATZE ZURÜCK 1.-2. GANG	KRANBRUECKE VORWÄRTS	KRANBRUECKE RÜCKWÄRTS	KRANBRUECKE VORW. SCHNELL	KRANBRUECKE RÜCKW. SCHNELL	KRANBRUECKE VORW. 1.-2. GANG	KRANBRUECKE ZUR. 1.-2. GANG	BEWEGUNG VORWÄRTS	BEWEGUNG RÜCKWÄRTS	LINKS
RECHTS	LAUFKATZE - LINKS	LAUFKATZE - RECHTS	LAUFKATZE LINKS SCHNELL	LAUFKATZE RECHTS SCHNELL	LAUFKATZE LINKS 1.-2. GANG	LAUFKATZE RECHTS 1.-2. GANG	KRANBRUECKE RECHTS	KRANBRUECKE LINKS	KRANBRÜCKE LINKS SCHNELL
WINDE LINKS LANGSAM RUNTER	KRANBRÜCKE RECHTS SCHNELL	KRANBRÜCKE LINKS 1.-2. GANG	KRANBRÜCKE RECHTS 1.-2. GANG	DREHUNG LINKS	DREHUNG RECHTS	DREHUNG LINKS SCHNELL	DREHUNG RECHTS SCHNELL	DREHUNG LINKS 1.-2. GANG	DREHUNG RECHTS 1.-2. GANG
DREHUNG LINKS 3. GANG	DREHUNG RECHTS 3. GANG	HÄNGETASTER LINKS	HÄNGETASTER RECHTS	LINKE LAUFKATZE	RECHTE LAUFKATZE	LANGSAM	SCHNELL	LAUFKATZE SCHNELL	KRANBRÜCKE SCHNELL
HEBEN - SCHNELL	DREHUNG - SCHNELL	WINDE PAAREN	OEFFNEN	SCHLIESSEN	ZANGE OEFFNEN	ZANGE SCHLIESSEN	GREIFER OEFFNEN	GREIFER SCHLIESSEN	DECKELÖFFNUNG
DECKELVERSCHLUSS	BESCHLEUNIGEN	VERZÖGERN	ANHEBEN	ABSENKEN	LADUNG	ABLADEN	ERREGEN	ABERREGEN	MAGNETISIERUNG
ENTMAGNETISIEREN	ANNÄHERN	ENTBLOCKKUNG	AUTOMATIK	HANDBETRIEB	HANDBETR. / AUTOMATIK	AUS HANDBETR. / AUTOMATIK	AN	AUS	AN - AUS
REIN	RAUS	NORD	SÜD	OST	WEST	UBERBELASTUNG	TARA	1-1+2-2	1-2-1+2
1+2	ON-OFF	A-A+B-B							

Label sheet - Spanish

MARCHA	ALARMA	MARCHA ALARMA	PARO	STOP	LUZ	MARCHA LINEA	PARO LINEA	MARCHA PALA	PARO PALA
FRENO	RETORNO	SUBIR	BAJAR	SUBIR ELEVACION	BAJAR ELEVACION	SUBIR ELEV. 1-2 VEL.	BAJAR ELEV. 1-2 VEL.	SUBIR ELEV. 3ª VEL.	BAJAR ELEV. 3ª VEL.
SUBIR ELEV. RAPIDA	BAJAR ELEV. RAPIDA	2ª VEL. ELEVACION	3ª VEL. ELEVACION	SUBIR AUX. ELEVACION	BAJAR AUX. ELEVACION	SUBIR ELEV. PRINCIPAL	BAJAR ELEV. PRINCIPAL	SUBIR ELEV. PRINC. RAPIDA	BAJAR ELEV. PRINC. RAPIDA
SUBIR AUX. 1-2 VEL.	BAJAR AUX. 1-2 VEL.	SUBIR PRINC. 1-2 VEL.	BAJAR PRINC. 1-2 VEL.	SUBIR POLIPASTO	BAJAR POLIPASTO	SUBIR POLIP. 1-2 VEL.	BAJAR POLIP. 1-2 VEL.	SUBIR POLIP. RAPIDO	BAJAR POLIP. RAPIDO
POLIP. DER. SUBIR LENTO	POLIP. DER. BAJAR LENTO	POLIP. DER. SUBIR RAPIDO	POLIP. DER. BAJAR RAPIDO	POLIP. IZQ. SUBIR LENTO	POLIP. IZQ. SUBIR RAPIDO	POLIP. IZQ. BAJAR RAPIDO	SUBIR GANCHO	BAJAR GANCHO	SUBIR GANCHO 1-2 VEL.
BAJAR GANCHO 1-2 VEL.	SUBIR GANCHO RAPIDO	BAJAR GANCHO RAPIDO	ADELANTE	ATRAS	ADELANTE CARRITO	ATRAS CARRITO	ADELANTE CARR. RAPIDO	ATRAS CARR. RAPIDO	ADELANTE CARR. 1-2 VEL.
ATRAS CARR. 1-2 VEL.	ADELANTE PUENTE	ATRAS PUENTE	ADELANTE PUENTE RAPIDO	ATRAS PUENTE RAPIDO	ADELANTE PUENTE 1-2 VEL.	ATRAS PUENTE 1-2 VEL.	ADELANTE TRASLACION	ATRAS TRASLACION	IZQUIERDA
DERECHA	IZQUIERDA CARRITO	DERECHA CARRITO	IZQUIERDA CARR. RAPIDO	DERECHA CARR. RAPIDO	IZQUIERDA CARR. 1-2 VEL.	DERECHA CARR. 1-2 VEL.	IZQUIERDA PUENTE	DERECHA PUENTE	IZQUIERDA PUENTE RAPIDO
POLIP. IZQUIER. BAJAR LENTO	DERECHA PUENTE RAPIDO	IZQUIERDA PUENTE 1-2 VEL.	DERECHA PUENTE 1-2VEL.	IZQUIERDA ROTACION	DERECHA ROTACION	IZQUIERDA ROT. RAPIDA	DERECHA ROT. RAPIDA	IZQUIERDA ROT. 1-2 VEL.	DERECHA ROT. 1-2 VEL.
IZQUIERDA ROT. 3ª VEL.	DERECHA ROT. 3ª VEL.	BOTONERA IZQUIERDA	BOTONERA DERECHA	CARRITO IZQUIERDO	CARRITO DERECHO	LENTO	RAPIDO	CARRITO RAPIDO	PUENTE RAPIDO
ELEVACION RAPIDA	ROTACION RAPIDA	ACOPLAMIENTO POLIPASTO	ABRIR	CERRAR	ABRIR PINZA	CERRAR PINZA	ABRIR PALA	CERRAR PALA	ABRIR PUERTA
CERRAR PUERTA	ACELERAR	DESACELERAR	ELEVAR	DESCENDER	CARGAR	DESCARGAR	IMANTAR	DESIMANTAR	IMANTAR MAGNETO
DESIMANTAR MAGNETO	ACERCAR	CONFIRMAR	AUTOMATICO	MANUAL	MAN-0-AUTO	OFF-MAN-AUTO	ON	OFF	ON-OFF
IN	OUT	NORTE	SUR	ESTE	OESTE	SOBRECARGA	TARA	1-1+2-2	1-2-1+2
1+2	ON-OFF	A-A+B-B							

MIKE - REQUEST FORM FOR NON STANDARD CONTROL STATION

Instructions

(See next page for list of components and legends)

Fill in the chart to the left according to the number of control elements required. Control stations are available with 4 to 15 control elements. It is possible to assemble a control element on the bottom of the control station only with enclosures with an even number of holes.

- 1 Control elements:** enter the number corresponding to the control element required (1 to 39) according to the legend. Eg. 25
- 2 Button disks:** for pushbuttons (1 to 3) enter the number corresponding to the disk required (50 to 88) according to the legend. Both full color disks and transparent disks (for illuminated buttons) are available. Eg. 57
- 3 Colour of selectors, mushrooms, pilot lights:** for toggle selector switches (15 to 24), impulse mushroom pushbuttons (7) and pilot lights (11) enter the letters corresponding to the colour required according to the legend. Eg. RP
- 4** If you choose disks with arrows (54 to 73), enter the direction of the arrow in the circle. Eg. ↗
- 5 Switches, LEDs and potentiometers:** enter the number corresponding to the switch, LED or potentiometer required (90 to 99) according to the legend. It is possible to enter up to 3 switches per position. Eg. 91
Two speed pushbuttons can activate two switches on the first speed and one switch on the second speed.
Selector switches can activate only two switches and possibly a LED.
ATTENTION: LEDs can be placed only in the central position and they are used for illuminated buttons and selector switches.
(See Control Element legend for switch activation).
- 6 Hook:** tick the box at the top or at the bottom if the hook is required. Eg. Hook
- 7 Cable sleeve and cable gland:** tick the box if the cable sleeve or the cable gland are required.
Eg. Sleeve
- 8 Mechanical interlock and ON-OFF actuator:** tick the boxes where the mechanical interlock (MI) between two control elements or the latched ON-OFF maintained actuator (LA) is required. Eg. MI
- 9 Protection:** when a control element is mounted on the bottom of the control station, it is possible to use a protection; in this case tick the box corresponding to the protection required. Eg. Small
- 10 Cover:** tick the box corresponding to the cover colour required (the base of the enclosure is always black).
- 11 SIL 1 certified:** tick the box if you require SIL 1 certified units for safety functions.
- 12 Label sheet:** stickers with letterings or symbols may be placed on the left and on the right of any control element. If label sheets are required, tick the corresponding box.
- 13 cULus certified:** tick the box if you require cULus certified units.

Control element on the bottom of the control station*

<input type="checkbox"/>	Control element	1		
<input type="checkbox"/>	Colour	3		
<input type="checkbox"/>	<input type="checkbox"/>	Switches	5	
<input type="checkbox"/>	<input type="checkbox"/>	<input type="checkbox"/>	Protection	9
Small	Large	None		

*ATTENTION: only mushroom pushbuttons ref. 4, 5, 6 with one or two switches, or **non illuminated** selector switches ref. 15, 16, 30, 31 with only one switch can be assembled on the bottom of the control station. LEDs cannot be mounted in this position.

Cover 10		SIL 1 certified 11
<input type="checkbox"/> Yellow	<input type="checkbox"/> Black	<input type="checkbox"/>

Label sheet 12		cULus certified 13
<input type="checkbox"/> Symbols	<input type="checkbox"/> English	<input type="checkbox"/> French
<input type="checkbox"/> Italian	<input type="checkbox"/> German	<input type="checkbox"/> Spanish
		<input type="checkbox"/>

1 Control elements	2 Button disks	3 Colour of selectors, mushrooms, pilot lights	4	6 Hook	7 Cable sleeve Cable gland	8	5 Switches and LEDs Potentiometer	
<input type="checkbox"/>	<input type="checkbox"/>	<input type="checkbox"/>	<input type="checkbox"/>	<input type="checkbox"/>	<input type="checkbox"/>	<input type="checkbox"/>	<input type="checkbox"/>	<input type="checkbox"/>
<input type="checkbox"/>	<input type="checkbox"/>	<input type="checkbox"/>	<input type="checkbox"/>	<input type="checkbox"/>	<input type="checkbox"/>	<input type="checkbox"/>	<input type="checkbox"/>	<input type="checkbox"/>
<input type="checkbox"/>	<input type="checkbox"/>	<input type="checkbox"/>	<input type="checkbox"/>	<input type="checkbox"/>	<input type="checkbox"/>	<input type="checkbox"/>	<input type="checkbox"/>	<input type="checkbox"/>
<input type="checkbox"/>	<input type="checkbox"/>	<input type="checkbox"/>	<input type="checkbox"/>	<input type="checkbox"/>	<input type="checkbox"/>	<input type="checkbox"/>	<input type="checkbox"/>	<input type="checkbox"/>
<input type="checkbox"/>	<input type="checkbox"/>	<input type="checkbox"/>	<input type="checkbox"/>	<input type="checkbox"/>	<input type="checkbox"/>	<input type="checkbox"/>	<input type="checkbox"/>	<input type="checkbox"/>
<input type="checkbox"/>	<input type="checkbox"/>	<input type="checkbox"/>	<input type="checkbox"/>	<input type="checkbox"/>	<input type="checkbox"/>	<input type="checkbox"/>	<input type="checkbox"/>	<input type="checkbox"/>
<input type="checkbox"/>	<input type="checkbox"/>	<input type="checkbox"/>	<input type="checkbox"/>	<input type="checkbox"/>	<input type="checkbox"/>	<input type="checkbox"/>	<input type="checkbox"/>	<input type="checkbox"/>
<input type="checkbox"/>	<input type="checkbox"/>	<input type="checkbox"/>	<input type="checkbox"/>	<input type="checkbox"/>	<input type="checkbox"/>	<input type="checkbox"/>	<input type="checkbox"/>	<input type="checkbox"/>
<input type="checkbox"/>	<input type="checkbox"/>	<input type="checkbox"/>	<input type="checkbox"/>	<input type="checkbox"/>	<input type="checkbox"/>	<input type="checkbox"/>	<input type="checkbox"/>	<input type="checkbox"/>
<input type="checkbox"/>	<input type="checkbox"/>	<input type="checkbox"/>	<input type="checkbox"/>	<input type="checkbox"/>	<input type="checkbox"/>	<input type="checkbox"/>	<input type="checkbox"/>	<input type="checkbox"/>
<input type="checkbox"/>	<input type="checkbox"/>	<input type="checkbox"/>	<input type="checkbox"/>	<input type="checkbox"/>	<input type="checkbox"/>	<input type="checkbox"/>	<input type="checkbox"/>	<input type="checkbox"/>
<input type="checkbox"/>	<input type="checkbox"/>	<input type="checkbox"/>	<input type="checkbox"/>	<input type="checkbox"/>	<input type="checkbox"/>	<input type="checkbox"/>	<input type="checkbox"/>	<input type="checkbox"/>
<input type="checkbox"/>	<input type="checkbox"/>	<input type="checkbox"/>	<input type="checkbox"/>	<input type="checkbox"/>	<input type="checkbox"/>	<input type="checkbox"/>	<input type="checkbox"/>	<input type="checkbox"/>
<input type="checkbox"/>	<input type="checkbox"/>	<input type="checkbox"/>	<input type="checkbox"/>	<input type="checkbox"/>	<input type="checkbox"/>	<input type="checkbox"/>	<input type="checkbox"/>	<input type="checkbox"/>
<input type="checkbox"/>	<input type="checkbox"/>	<input type="checkbox"/>	<input type="checkbox"/>	<input type="checkbox"/>	<input type="checkbox"/>	<input type="checkbox"/>	<input type="checkbox"/>	<input type="checkbox"/>
<input type="checkbox"/>	<input type="checkbox"/>	<input type="checkbox"/>	<input type="checkbox"/>	<input type="checkbox"/>	<input type="checkbox"/>	<input type="checkbox"/>	<input type="checkbox"/>	<input type="checkbox"/>
<input type="checkbox"/>	<input type="checkbox"/>	<input type="checkbox"/>	<input type="checkbox"/>	<input type="checkbox"/>	<input type="checkbox"/>	<input type="checkbox"/>	<input type="checkbox"/>	<input type="checkbox"/>
<input type="checkbox"/>	<input type="checkbox"/>	<input type="checkbox"/>	<input type="checkbox"/>	<input type="checkbox"/>	<input type="checkbox"/>	<input type="checkbox"/>	<input type="checkbox"/>	<input type="checkbox"/>
<input type="checkbox"/>	<input type="checkbox"/>	<input type="checkbox"/>	<input type="checkbox"/>	<input type="checkbox"/>	<input type="checkbox"/>	<input type="checkbox"/>	<input type="checkbox"/>	<input type="checkbox"/>
<input type="checkbox"/>	<input type="checkbox"/>	<input type="checkbox"/>	<input type="checkbox"/>	<input type="checkbox"/>	<input type="checkbox"/>	<input type="checkbox"/>	<input type="checkbox"/>	<input type="checkbox"/>
<input type="checkbox"/>	<input type="checkbox"/>	<input type="checkbox"/>	<input type="checkbox"/>	<input type="checkbox"/>	<input type="checkbox"/>	<input type="checkbox"/>	<input type="checkbox"/>	<input type="checkbox"/>
<input type="checkbox"/>	<input type="checkbox"/>	<input type="checkbox"/>	<input type="checkbox"/>	<input type="checkbox"/>	<input type="checkbox"/>	<input type="checkbox"/>	<input type="checkbox"/>	<input type="checkbox"/>



1 Legend - Control elements

* SWITCH ACTIVATION
 It is possible to mount up to 3 switches for each control element. The chart on the right of each pushbutton or selector switch specifies which position activates the switch on the top, in the middle or on the bottom. If the selector switches are mounted with the lever facing downwards, then the activation of the switches is reversed. Eg.: 2 speed pushbutton: the first speed activates the switches on the top and in the middle, while the second speed activates the switch on the bottom.

Pushbuttons

It is possible to mount up to 3 switches for each button. LEDs can be mounted only in the middle.

		SWITCH ACTIVATION*
1	1 speed pushbutton with disk	<input type="checkbox"/> speed 1
25	1 speed black pushbutton	<input type="checkbox"/> speed 1
26	1 speed grey pushbutton	<input type="checkbox"/> speed 1
2	2 speed pushbutton with disk	<input type="checkbox"/> speed 1 <input type="checkbox"/> speed 1 <input type="checkbox"/> speed 2
27	2 speed black pushbutton	<input type="checkbox"/> speed 1 <input type="checkbox"/> speed 2
28	2 speed grey pushbutton	<input type="checkbox"/> speed 1 <input type="checkbox"/> speed 2
3	1 speed illuminated pushbutton with disk	<input type="checkbox"/> speed 1 <input type="checkbox"/> LED <input type="checkbox"/> speed 1

Mushroom pushbuttons

All mushroom pushbuttons activate all the switches at the same time.

- 4 Latched mushroom pushbutton for emergency stop
- 5 Latched mushroom pushbutton for emergency stop Ø 40 mm
- 6 Key mushroom pushbutton
- 7 Impulse mushroom pushbutton Ø 33 mm with black base
- 8 Impulse black mushroom pushbutton Ø 40 mm with yellow base
- 9 Impulse black mushroom pushbutton Ø 40 mm with yellow base and protective cap

- 11 Pilot light
- 12 Blanking plug

Toggle selector switches

It is possible to mount only 2 switches for each selector. In the middle it is possible to mount only the LED for illuminated selector switches.

		SWITCH ACTIVATION*
15	0/1 spring return	<input type="checkbox"/> pos 1 <input type="checkbox"/> pos 1
16	0/1 maintained positions	<input type="checkbox"/> pos 1 <input type="checkbox"/> pos 1
17	1/0/2 spring return	<input type="checkbox"/> pos 1 <input type="checkbox"/> pos 2
18	1/0/2 maintained positions	<input type="checkbox"/> pos 1 <input type="checkbox"/> pos 2
19	1/1+2/2 spring return	<input type="checkbox"/> pos 1 and 1+2 <input type="checkbox"/> pos 2 and 1+2
20	1/1+2/2 maintained positions	<input type="checkbox"/> pos 1 and 1+2 <input type="checkbox"/> pos 2 and 1+2
21	0/1/1+2 spring return	<input type="checkbox"/> pos 1+2 <input type="checkbox"/> pos 1 and 1+2
22	0/1/1+2 maintained positions	<input type="checkbox"/> pos 1+2 <input type="checkbox"/> pos 1 and 1+2
23	1/2 spring return	<input type="checkbox"/> pos 1 <input type="checkbox"/> pos 2
24	1/2 maintained positions	<input type="checkbox"/> pos 1 <input type="checkbox"/> pos 2

Key selector switches

It is possible to mount only 2 switches for each selector, and no switch/LED in the central position.

		SWITCH ACTIVATION*
30	0/1 spring return key out in position 0	<input type="checkbox"/> pos 1 <input type="checkbox"/> NA <input type="checkbox"/> pos 1
31	0/1 maintained positions key out in position 0	<input type="checkbox"/> pos 1 <input type="checkbox"/> NA <input type="checkbox"/> pos 1
32	1/0/2 spring return key out in position 0	<input type="checkbox"/> pos 1 <input type="checkbox"/> NA <input type="checkbox"/> pos 2
33	1/0/2 maintained positions key out in position 0	<input type="checkbox"/> pos 1 <input type="checkbox"/> NA <input type="checkbox"/> pos 2
34	0/1/1+2 spring return key out in position 0	<input type="checkbox"/> pos 1+2 <input type="checkbox"/> NA <input type="checkbox"/> pos 1 and 1+2
35	0/1/1+2 maintained positions key out in position 0	<input type="checkbox"/> pos 1+2 <input type="checkbox"/> NA <input type="checkbox"/> pos 1 and 1+2
36	1/2 change over spring return key out in position 1	<input type="checkbox"/> pos 1 <input type="checkbox"/> NA <input type="checkbox"/> pos 2
37	1/2 change over maintained positions key out in position 1	<input type="checkbox"/> pos 1 <input type="checkbox"/> NA <input type="checkbox"/> pos 2
38	1/1+2/2 spring return key out in position 1+2	<input type="checkbox"/> pos 1 and 1+2 <input type="checkbox"/> NA <input type="checkbox"/> pos 2 and 1+2
39	1/1+2/2 maintained positions key out in position 1+2	<input type="checkbox"/> pos 1 and 1+2 <input type="checkbox"/> NA <input type="checkbox"/> pos 2 and 1+2

2 Legend - Button disks

Full colour and symbol disks for pushbuttons (ref. 1 and 2)

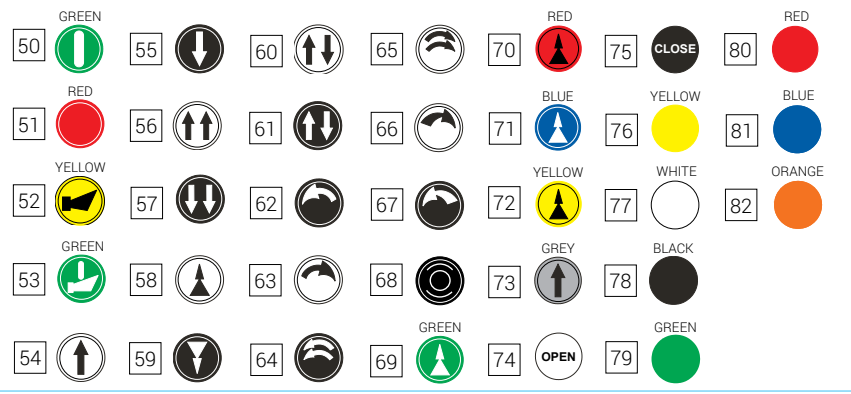

Transparent disks for illuminated pushbuttons (ref. 3)

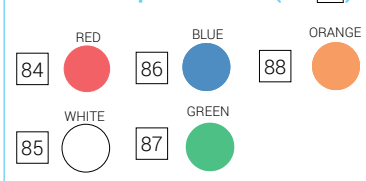

3 Legend - Colour of selector switches, mushroom pushbuttons, pilot lights

Non-illuminated toggle selector switches (ref. 15 to 24)

RP	Red	BP	Blue	AP	Orange
GP	Yellow	VP	Green	WP	White

Impulse mushroom pushbutton with black base (ref. 7)

R	Red	B	Blue	A	Orange
G	Yellow	V	Green	N	Black

Illuminated toggle selector switches (ref. 15 to 24)

RI	Red	BI	Blue	AI	Orange
GI	Yellow	VI	Green	WI	White

Pilot lights (ref. 11)

R	Red	B	Blue	A	Orange
G	Yellow	V	Green	W	White

